

IC-P 100

PARAPET INSPECTION CHAMBER



ArchiGreen Roof Ltd
3 Patzay Pal Utca • Gyor • H-9024
Website: www.archigreenroof.com
E-mail: info@archigreenroof.com

IC-P 100 is a 100 mm high lockable parapet inspection chamber comprising four elements:

- A. The base, a square-shaped casing with an open underside, is made of UV-resistant polypropylene (PP). Cant strips and pre-defined cutting lines are exclusive to the base of the IC-P.
- B. The lid, detachable, is made of PP.
- C. The filter grille is made of stainless steel.
- D. The lock, chrome-plated durable quarter turn lock, is made of zinc alloy.

The filter grille and the lock are integrated into the lid that is recessed into the base. The detachable lid has tread pattern on its surface to prevent slipping hazards.

Screws are made of stainless steel (Grade A2) and their fixing is in accordance with DIN7505.

IC-P stands on 2 expanded load distribution footprints.

Use

Usage of the IC-P range include:

- Allowing for the inspection and maintenance of outlets
- Securing proper and continuous drainage of surface water
- Preventing contamination and direct sunlight into the outlets
- Restraining the recommended pebble vegetation barrier
- Stopping plants from growing over the outlet
- Accomodating alternative size of fillets near parapets

Application area

IC-P 100 parapet inspection chamber is directly installed over each green / gravel roof outlet, located near the parapet, set on the drainage layer within a surrounding build-up of 100 mm in depth.

Size (L x W x H)	300 x 300 x 100 mm
Weight	1.83 kg
Base and lid	Polypropylene (PP)
Colour	RAL 7032 - pebble grey
Filter grille	Stainless steel
Perforations of filter grille	German FLL Guidelines
Area of filter grille	2534 mm ²
Effective drainage area	1300 mm ²
Screws (Grade)	Stainless steel (A2)
Screws fixing standard	German Standard DIN 7505
Lock	Zinc alloy die casting
Finish of lock	Chrome-plated
Load distribution surface	30,653 mm ²
Environmental aspect	Fully recyclable

Installation example

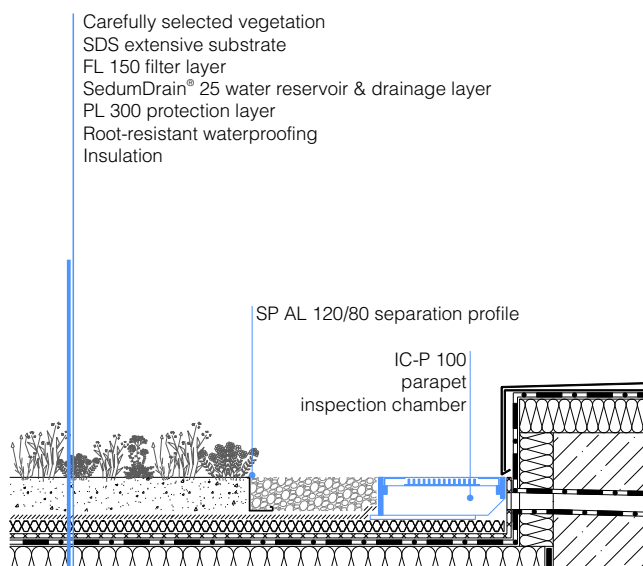

Specification suggestion

ArchiGreen® IC-P 100 lockable parapet inspection chamber is made of UV-resistant polypropylene (PP), RAL colour 7032, with a stainless steel filter grille and a durable chrome-plated quarter turn lock made of zinc die casting alloy fitted into its detachable lid. Anti-slip tread pattern marks the surface of the lid. Cant strips and pre-defined cutting lines are to accommodate alternative sizes of fillets when installed on outlets located near the parapet. The grille allows for the inflow of surface water via 1300 mm² perforated area according to German FLL Guidelines. Size and weight including lid: 300 x 300 x 100 mm (L x W x H); 1.83 kg. Two expanded load distribution footprints are fixed to the underside via stainless steel screws (Grade: A2). Fastener fixing standard: German Standard DIN 7505. Delivery and installation is in accordance with manufacturer's instructions.

Technical illustration

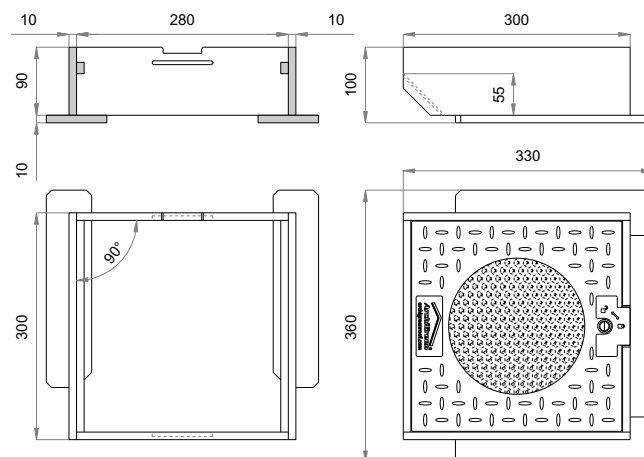

Tools required

No special tools are required for the installation of this product.

Packaging unit

IC-P 100 can be despatched in corrugated boxes or on wooden pallets depending on the size of the order. 90 units of IC-P 100 being stretch wrapped would fit on a single EUR-pallet (1200x800 mm).